



# MAZDA CX-60

PRICES & SPECIFICATIONS



## NEW 2025 MAZDA CX-60

Introducing the new 2025 Mazda CX-60, our luxury SUV that redefines elegance and power. Masterfully crafted using our award-winning Kodo: Soul of Motion design philosophy, its bold exterior effortlessly complements an exquisitely appointed interior, a driver-centric cabin, and Mazda's legendary driving dynamics—creating an unparalleled driving experience that fuses luxury with exceptional handling.

The Mazda CX-60 offers a range of powertrains, each showcasing cutting-edge Mazda technology. Our first Plug-in Hybrid Electric Vehicle (PHEV) delivers remarkable performance and exceptional environmental credentials, achieving an impressive 201.8mpg with CO<sub>2</sub> emissions from just 32g/km.

Also available is our latest e-Skyactiv Diesel technology, offered in both 200ps rear-wheel drive and 254ps Mazda i-Activ all-wheel drive variants. Featuring groundbreaking advanced combustion technology, this diesel engine ranks among the cleanest in the world.

Undoubtedly, the Mazda CX-60 will captivate you from the very first glance.

Model available on the  

**6** YEAR MAZDA  
WARRANTY



CRAFTED IN JAPAN

## THE LATEST IN TECHNOLOGY & CONVENIENCE

### MAZDA CONNECT

#### The latest in-car infotainment

Mazda Connect offers effortless connectivity between you and your Mazda, with information displayed on a stunningly clear 12.3" central screen, perfectly positioned at eye level.

Access essential vehicle information and settings, enjoy entertainment options such as DAB Radio, and seamlessly connect your smartphone via Bluetooth to make calls, view contacts, and utilise the comprehensive European-wide hybrid navigation system to provide traffic updates and route options, all with 7-years of free map updates.



### WIRELESS APPLE CARPLAY® & ANDROID AUTO™

#### Smarter, safer way to use your smartphone

With wireless Apple CarPlay®, get easy access to Apple Music, Maps, Messages and make phone calls with Siri through the car's Multimedia Commander and touchscreen.

Wireless Android Auto™ also allows you to access your favourite music and messaging apps, Google Maps and YouTube Music. Google Assistant voice control helps you send and receive messages, make calls, get directions and plan your day while you keep your eyes safely on the road.

## THE LATEST IN TECHNOLOGY & CONVENIENCE

### MAZDA Mi-DRIVE

#### Intelligent Drive Select System

Mi-DRIVE is a system that switches driving modes depending on the road and vehicle conditions. Featured on all grades, Sport mode enhances vehicle responsiveness when the accelerator pedal is pressed.

All-Wheel Drive models gain additional functionality. When driving on rough terrain and slippery road conditions, Off-Road mode prevents the driven wheels from spinning when driving, improving road-holding performance. Towing mode optimises driving performance due to increased weight when towing a trailer, refining vehicle stability. PHEV models also benefit from EV mode which allows you to drive the vehicle utilising the electrical motor, cutting down on fuel usage and emissions.



### MYMAZDA APP CONNECTIVITY

#### Controls at your fingertips

The Mazda CX-60 can share vehicle information with the MyMazda app via Connected Services. This provides several features which enhances the connection between you and your Mazda.

In addition, the Mazda CX-60 PHEV has the ability to not only monitor and control your charging, but also has the ability to heat or cool the cabin prior to your departure, as well as control the front and rear defrost function on those frosty mornings.

Further information on these features and more can be found at [www.mazda.co.uk/owners/connectivity/](http://www.mazda.co.uk/owners/connectivity/)

## THE LATEST IN TECHNOLOGY & CONVENIENCE

### 12.3" COLOUR ACTIVE DRIVING DISPLAY

#### Key information within your eyeline

Fitted as standard, the 12.3" colour Active Driving Display is a technology feature that projects key information directly onto the windscreen within the driver's line of sight.

Information includes vehicle speed, cruise control settings and will provide satellite navigation directions in relation to the Mazda Navigation System.



### 12.3" DIGITAL INSTRUMENT CLUSTER

#### Immerse yourself in the drive

Working in harmony with the Mi-DRIVE system, the digital instrument cluster provides individual driving displays for each driving mode. This ensures that the instrument cluster displays the most important information, which in combination with the 12.3" Active Driving Display (Head-up display) contributes to a safer driving environment, as well as helping the driver to immerse themselves more in the drive.

## THE LATEST IN TECHNOLOGY & CONVENIENCE

### BOSE PREMIUM SOUND SYSTEM

#### Made to move you

The high-performance speakers make you feel like you're at the front row of your favourite concert, making you feel immersed in whatever you're listening to.

The premium sound system includes all the latest Bose technologies such as CenterPoint, BassMatch and AudioPilot which all contribute to an immersive entertainment experience.

(Not available on Exclusive-Line grades)



### MULTIMEDIA COMMANDER

#### Easy to use, driver centric, eyes on the road

The Multimedia Commander provides simple and easy access to the Mazda Connect infotainment system. The tactile feel plays to the senses allowing for ease of use whilst on the move, and more importantly, allows you to keep your eyes on the road.

## WEEKEND AWAY, PACK YOUR BAGS

Your ultimate companion for the perfect weekend getaway. With a spacious 570-litre boot, the Mazda CX-60 ensures you can bring everything you need. Practicality is taken to new heights with the 40:20:40 split rear seats, offering versatile loading options and expanding capacity to an impressive 1,726 litres.

Need to load the boot with your hands full? No problem—simply swipe your foot beneath the rear bumper, and the hands-free power liftgate will effortlessly open or close.



## BUILT TO TOW UP TO 2,500KG

Mazda believe in the 'right-sized' approach to engine capacity. By increasing the engine's size of both our PHEV and Diesel powertrains, we create a larger combustion chamber that allows for a more powerful and efficient combustion process. The result? Lower emissions, exceptional fuel economy, and a surge of torque that provides you with the ability to tow up to 2,500kg.

It's the perfect combination of performance and sustainability - engineered to give you an exhilarating and unforgettable driving experience!



## ADDED REASSURANCE

The PHEV provides up to 500Nm of torque whilst the Diesel offers up to 550Nm. Our i-ACTIV AWD system provides increased torque to the rear wheels, improving stability on Motorways and unpaved roads, whilst the Dynamic Stability Control enhances traction through rough terrain.

Stability is the most important quality you can look for in a tow car, which is why both our Trailer Stability Control, and our Mi-DRIVE Intelligent Drive Select System (which provides a bespoke Towing mode<sup>^</sup>), are designed to increase the stability of the vehicle during towing. Helping to suppress any potential swaying and providing a smooth confident drive.

<sup>^</sup>Activates once you equip your Mazda CX-60 with an approved Mazda Tow Bar.

## EXCLUSIVE-LINE

from £46,940



Mazda CX-60 327ps AWD Exclusive-Line Auto in Platinum Quartz



18" Grey alloy wheels



Black leather seat trim^

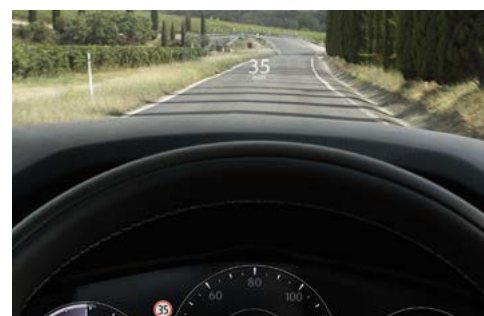

Windscreen projected colour Active Driving Display



12.3-inch TFT colour centre display

## STANDARD FEATURES

### EXTERIOR

- 18" Grey alloy wheels
- Body coloured electrically adjustable, heated, auto power-folding door mirrors
- Front and rear parking sensors
- Front grille in Piano Black (bar type) with Chrome finish Signature Wing
- Front rain-sensing wipers
- Front wiper de-icer
- LED headlights with auto levelling
- Coming home/leaving home lights
- Dusk-sensing headlights
- LED daytime running lights
- High Beam Control
- Handsfree power liftgate
- Reversing camera
- Wheel arch and side sill mouldings - satin black

### INTERIOR

- Black leather seat trim^
- Colour 12.3" TFT instrument cluster display (provides speed, traffic signs and cruise control information)
- Frameless auto-dimming rear-view mirror
- Heated leather-wrapped steering wheel
- Grey roof lining
- Seats (front)
  - Driver seat manual tilt, slide, recline and height adjustment
  - Passenger seat manual slide, recline and height adjustment
  - Heated with 3-stage setting
- Seats (rear)
  - 40:20:40 split fold down rear seats
  - Manual recline
  - Folding centre armrest equipped w/2 cup holders

### SAFETY & SECURITY

- Blind Spot Monitoring with Rear Cross Traffic Alert
- e-Call with GPS
- Emergency Lane-Keeping with:
  - Road Keep Assist
  - Blind Spot Assist
- Hill Descent Control (AWD models only)
- Lane-keep Assist System with Lane Departure Warning System
- Rear Cross Traffic Alert
- Smart Brake Support - Front with Turn Across Traffic
- Smart keyless entry
- Traffic Sign Recognition
- Vehicle exit warning

### CHARGING (PHEV ONLY)

- AC Charging cable for home and public fast chargers
- AC Charging cable for UK 3-pin plug socket

### COMFORT & CONVENIENCE

- Cruise Control with Adjustable Speed Limiter
- Dual-zone climate control air-conditioning with rear air-vents
- Mi-DRIVE: drive mode selection
- Windscreen Projected colour Active Driving Display (Head-up Display)

### INFOTAINMENT

- AM / FM / DAB radio, with 8 speakers and USB-C inputs
- Connected Services\*
- Integrated Bluetooth®
- Mazda Connect multimedia system with 12.3" Colour centre display and Multimedia Commander
- Mazda Navigation System with European mapping and 7-years free map updates
- Wireless Apple CarPlay® & Android Auto™

\*Connected Services is a subscription service and requires a compatible mobile device to download and sign-up to the MyMazda App. A 7-year complimentary period is included and commences from the date of first registration of the vehicle. Please contact your dealer or visit [www.mazda.co.uk/my-mazda](http://www.mazda.co.uk/my-mazda) for further information. ^Leather refers to centre seat facing and side supports. Pricing and specification are subject to change. Please speak with your local dealer for latest pricing information.

# HOMURA

from £50,090



Mazda CX-60 327ps AWD Homura Auto in Soul Red Crystal



20" Black alloy wheels



Black Nappa leather seat trim^



Front grille in Piano black (honeycomb type) with Dark plated finish Signature Wing



12 Bose speaker surround-sound system

## STANDARD FEATURES - in addition to Exclusive-Line, Homura adds:

### EXTERIOR

- 20" Black alloy wheels
- Front grille in Piano Black (honeycomb type) with Dark plated finish Signature Wing
- Gloss black wing mirrors with memory and selectable tilt-down function when in reverse
- Wheel arch and side sill mouldings - body coloured

### INTERIOR

- Black roof lining
- Black Nappa leather seat trim^
- Seats (front)
  - Driver and front passenger seat electric tilt, slide, recline, height and lumbar adjustment
  - Mazda Driver Personalisation System
  - Driver seat ingress/ Egress support & automatic driver position guide
  - Ventilation with 3-stage setting
- Seats (rear)
  - Heated outer rear seats with 3-stage setting
- Electric steering wheel adjustment
- Door pocket illumination with front & rear door courtesy lamps

### COMFORT & CONVENIENCE

- Ambient interior lighting

### INFOTAINMENT

- 12 Bose speaker surround-sound system featuring Bose Centerpoint signal processing and AudioPilot 2 noise compensation technology

### SAFETY AND SECURITY

- Driver Monitoring

# HOMURA PLUS

from £52,890



Mazda CX-60 254ps AWD Homura Plus Auto in Zircon Sand

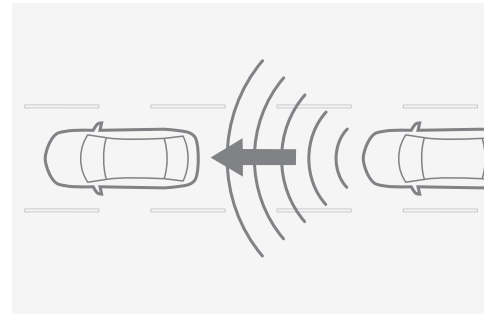

Mazda Radar Cruise Control



Panoramic Sunroof

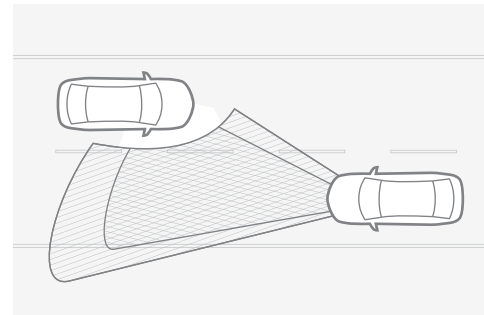

Adaptive LED Headlights

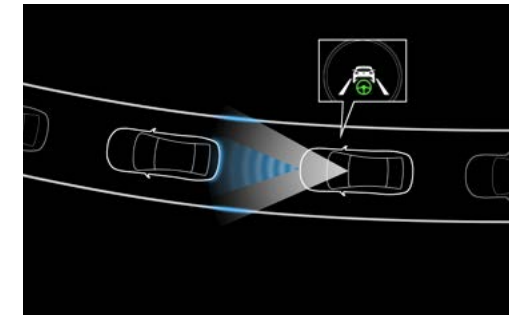

Cruising & Traffic Support

## STANDARD FEATURES - in addition to Homura, Homura Plus adds:

### EXTERIOR

- 360° View Monitor with see through view
- Adaptive LED Headlights
- Rear privacy glass
- Panoramic sunroof

### INTERIOR

- Electrical power outlet
  - 150W AC socket
  - 1500W AC socket (PHEV models only)
- Front centre console storage illumination

### COMFORT & CONVENIENCE

- Mazda Radar Cruise Control (MRCC) (Features Stop & Go function)
- Cruising & Traffic Support (CTS)
- Intelligent Speed Assistance (ISA)
- Front Cross Traffic Alert (FCTA)
- Smart Brake Support - Rear
- Smart Brake Support - Rear Crossing

### INFOTAINMENT

- Qi Wireless Charging

# TAKUMI

from £51,040



Mazda CX-60 327ps AWD Takumi Auto in Rhodium White



20" Black Diamond Cut alloy wheels



White Nappa Leather seat trim<sup>^</sup>



White Maple wood interior accents



Dashboard panel trimmed in woven fabric with Kakenui inspired stitching

## STANDARD FEATURES - in addition to Exclusive-Line, Takumi adds:

### EXTERIOR

- 20" Black Diamond Cut alloy wheels
- Body coloured wing mirrors with memory and selectable tilt-down function when in reverse
- Wheel arch and side sill mouldings - body coloured

### INTERIOR

- Seats (front)
  - Driver and front passenger seat electric tilt, slide, recline, height and lumbar adjustment
  - Mazda Driver Personalisation System
  - Driver seat ingress/ Egress support & automatic driver position guide
  - Ventilation with 3-stage setting
- Seats (rear)
  - Heated outer rear seats with 3-stage setting
- Electric steering wheel adjustment
- Leather wrapped steering wheel with white stitching
- White Maple wood interior accents
- Dashboard panel trimmed in woven fabric with Kakenui inspired stitching
- White Nappa leather seat trim<sup>^</sup>
- Door pocket illumination with front & rear door courtesy lamps

### COMFORT & CONVENIENCE

- Ambient interior lighting

### INFOTAINMENT

- 12 Bose speaker surround-sound system featuring Bose Centerpoint signal processing and AudioPilot 2 noise compensation technology

<sup>^</sup>Leather refers to centre seat facing and side supports. Pricing and specification are subject to change. Please speak with your local dealer for latest pricing information.

# TAKUMI PLUS

from £53,840



Mazda CX-60 254ps AWD Takumi Plus Auto in Machine Grey

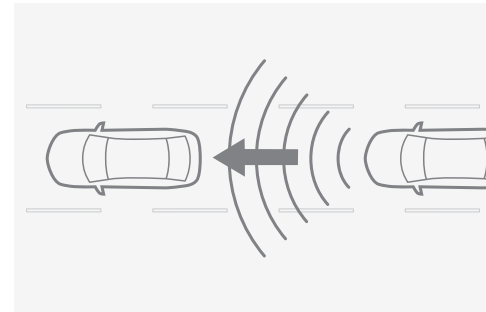

Mazda Radar Cruise Control



Panoramic Sunroof



360° View Monitor with see view view

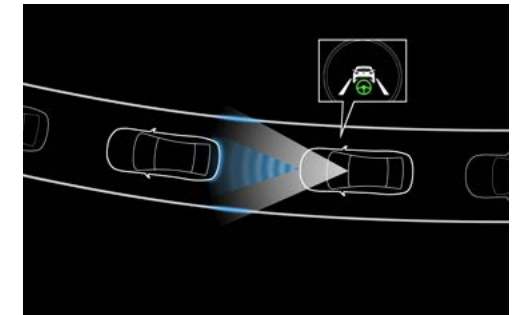

Cruising and Traffic Support

## STANDARD FEATURES - in addition to Takumi, Takumi Plus adds:

### EXTERIOR

- 360° View Monitor with see through view
- Adaptive LED Headlights
- Rear privacy glass
- Panoramic sunroof

### INTERIOR

- Electrical power outlet
  - 150W AC socket
  - 1500W AC socket (PHEV models only)
- Front centre console storage illumination

### COMFORT & CONVENIENCE

- Mazda Radar Cruise Control (MRCC) (Features Stop & Go function)
- Cruising & Traffic Support (CTS)
- Intelligent Speed Assist (ISA)
- Front Cross Traffic Alert (FCTA)
- Smart Brake Support - Rear
- Smart Brake Support - Rear Crossing

### INFOTAINMENT

- Qi Wireless Charging

# OPTION PACKS

## PHEV - COMFORT PACK

£1,400

Optional on Exclusive-Line

- 20" Silver alloy wheels
- Driver door mirror memory with tilt-down function when in reverse
- Driver Monitoring
- Driver and front passenger electric slide, recline, height and lumbar adjustment
- Front seat ventilation
- Heated outer rear seats
- Mazda Driver Personalisation System: (excludes steering wheel function & Ingress/Egress support)

## DIESEL - COMFORT PACK

£1,400

Optional on Exclusive-Line

- 20" Silver alloy wheels
- Driver door mirror memory with tilt-down function when in reverse
- Driver Monitoring
- Driver and front passenger electric slide, recline, height and lumbar adjustment
- Front seat ventilation
- Heated outer rear seats
- Mazda Driver Personalisation System: (excludes steering wheel function & Ingress/Egress support)

## PHEV - CONVENIENCE & DRIVER ASSISTANCE PACK<sup>^</sup>:

£2,100

Optional on Exclusive-Line, Homura, & Takumi

- 360° View Monitor with see through view
- Qi Wireless Charging
- 1500W AC socket (PHEV models only)
- 150W AC socket
- Centre console storage illumination
- Door pocket illumination with front & rear door courtesy lamps<sup>~</sup>
- Rear privacy glass
- Cruising & Traffic Support
- Intelligent Speed Assistance
- Front Cross Traffic Alert
- Smart Brake Support - Rear
- Smart Brake Support - Rear Crossing
- Mazda Radar Cruise Control (features Stop & Go function)
- Adaptive LED Headlights

## DIESEL - CONVENIENCE & DRIVER ASSISTANCE PACK<sup>^</sup>:

£1,900

Optional on Exclusive-Line, Homura. Standard on Takumi

- 360° View Monitor with see through view
- Qi Wireless Charging
- 150W AC socket
- Centre console storage illumination
- Door pocket illumination with front & rear door courtesy lamps<sup>~</sup>
- Rear privacy glass
- Cruising & Traffic Support
- Intelligent Speed Assistance
- Front Cross Traffic Alert
- Smart Brake Support - Rear
- Smart Brake Support - Rear Crossing
- Mazda Radar Cruise Control (features Stop & Go function)
- Adaptive LED Headlights

## PHEV - PANORAMIC SUNROOF\*

£1,000

Optional on Homura & Takumi

## DIESEL - PANORAMIC SUNROOF\*

£1,000

Optional on Homura. Standard on Takumi.

<sup>^</sup>Optional on Exclusive-Line, Homura & Takumi grades. Only available in conjunction with Comfort Pack on Exclusive-Line models. Standard on Homura Plus and Takumi Plus grades.

\*Optional on Homura grades. Standard on Homura Plus and Takumi Plus grades.

<sup>~</sup>Part of Convenience & Driver Assistance Pack on Exclusive-Line only. For all other grades, this feature comes as standard.

# PRICING

e-SKYACTIV PHEV	PRICE	VAT	P11D VALUE	FIRST YEAR VED & DVLA FIRST REG FEE*	RECOMMENDED 'ON THE ROAD' RETAIL†	CO <sub>2</sub> EMISSIONS COMBINED (g/km)~	BIK TAX (%)^	2025/26 MONTHLY TAX LIABILITY 20%/40%	INSURANCE GROUP
Mazda CX-60 2.5 327ps AWD Exclusive-Line Auto†	£38,979.17	£7,795.83	£46,775	£165	£46,940	32	9%	£70/£140	38A
Mazda CX-60 2.5 327ps AWD Homura Auto†	£41,604.17	£8,320.83	£49,925	£165	£50,090	32	9%	£75/£150	39A
Mazda CX-60 2.5 327ps AWD Homura Plus Auto†	£43,937.50	£8,787.50	£52,725	£165	£52,890	33	9%	£79/£158	39A
Mazda CX-60 2.5 327ps AWD Takumi Auto†	£42,395.83	£8,479.17	£50,875	£165	£51,040	32	9%	£76/£153	39A
Mazda CX-60 2.5 327ps AWD Takumi Plus Auto†	£44,729.17	£8,945.83	£53,675	£165	£53,840	32	9%	£81/£161	39A

\* First year rate Vehicle Excise Duty as of 1 April 2025, includes £55 DVLA first registration fee.

† If any vehicle has a list price of over £40,000 (including VAT, paint, and factory fitted options) at first registration, the customer will have to pay an additional VED charge (currently £425) for five years from the start of the second licence (in addition to the standard VED charge per year, currently £195 for all vehicles).

^ BIK effective from 6 April 2025.

~ Figures shown are for comparability purposes; only compare fuel consumption and CO<sub>2</sub> figures with other cars tested to the same technical procedures. These figures may not reflect real life driving results, which will depend upon a number of factors including the accessories fitted (post-registration), variations in weather, driving styles and vehicle load. All figures quoted are derived from the latest WLTP test cycle.

Pricing and specification are subject to change. Please speak with your local dealer for latest pricing information.

## FACTORY FITTED OPTIONS

	BASIC PRICE	VAT	MSRP
<b>Comfort Pack<sup>1)</sup>:</b> - 20" Silver alloy wheels - Driver door mirror memory with tilt-down function when in reverse - Driver Monitoring - Driver and front passenger electric slide, recline, height and lumbar adjustment - Front seat ventilation - Heated outer rear seats - Mazda Driver Personalisation System: (excludes steering wheel function & Ingress/Egress support)	£1,166.67	£233.33	£1,400
<b>Convenience &amp; Driver Assistance Pack<sup>2)</sup>:</b> - 360° Monitor with see through view - Qi Wireless Charging - 1500W AC Socket - 150W AC socket - Centre console storage illumination - Door pocket illumination with front & rear door courtesy lamps <sup>3)</sup> - Rear privacy glass - Cruising & Traffic Support - Intelligent Speed Assistance - Front Cross Traffic Alert - Smart Brake Support - Rear - Smart Brake Support - Rear Crossing - Mazda Radar Cruise Control (features Stop & Go function) - Adaptive LED Headlights	£1,750.00	£350.00	£2,100
<b>Panoramic sunroof<sup>4)</sup></b>	£833.33	£166.67	£1,000

<sup>1)</sup> Optional on Exclusive-Line models only.

<sup>2)</sup> Optional on Exclusive-Line, Homura & Takumi grades. Only available in conjunction with Comfort Pack on Exclusive-Line models. Standard on Homura Plus and Takumi Plus grades.

<sup>3)</sup> As part of the contents for Exclusive-Line grades. Item is as standard on all other grades.

<sup>4)</sup> Optional on Homura grades. Standard on Homura Plus and Takumi Plus grades.

# PRICING

e-SKYACTIV D MHEV	PRICE	VAT	P11D VALUE	FIRST YEAR VED & DVLA FIRST REG FEE*	RECOMMENDED 'ON THE ROAD' RETAIL†	CO <sub>2</sub> EMISSIONS COMBINED (g/km)~	BIK TAX (%)^	2025/26 MONTHLY TAX LIABILITY 20%/40%	INSURANCE GROUP
Mazda CX-60 3.3 200ps 2WD Exclusive-Line Auto†	£38,670.83	£7,734.17	£46,405	£595	£47,000	131	32%	£247/£495	33A
Mazda CX-60 3.3 254ps AWD Exclusive-Line Auto†	£40,879.17	£8,175.83	£49,055	£595	£49,650	138	33%	£270/£540	38A
Mazda CX-60 3.3 254ps AWD Homura Auto†	£43,504.17	£8,700.83	£52,205	£595	£52,800	140	34%	£296/£592	38A
Mazda CX-60 3.3 254ps AWD Homura Plus Auto†	£45,670.83	£9,134.17	£54,805	£595	£55,400	142	34%	£311/£621	39A
Mazda CX-60 3.3 254ps AWD Takumi Auto†	£44,295.83	£8,859.17	£53,155	£595	£53,750	140	34%	£301/£602	39A
Mazda CX-60 3.3 254ps AWD Takumi Plus Auto†	£46,462.50	£9,292.50	£55,755	£595	£56,350	142	34%	£316/£632	39A

\* First year rate Vehicle Excise Duty as of 1 April 2025, includes £55 DVLA first registration fee.

† If any vehicle has a list price of over £40,000 (including VAT, paint, and factory fitted options) at first registration, the customer will have to pay an additional VED charge (currently £425) for five years from the start of the second licence (in addition to the standard VED charge per year, currently £195 for all vehicles).

^ BIK effective from 6 April 2025.

~ Figures shown are for comparability purposes; only compare fuel consumption and CO<sub>2</sub> figures with other cars tested to the same technical procedures. These figures may not reflect real life driving results, which will depend upon a number of factors including the accessories fitted (post-registration), variations in weather, driving styles and vehicle load. All figures quoted are derived from the latest WLTP test cycle.

Pricing and specification are subject to change. Please speak with your local dealer for latest pricing information.

## FACTORY FITTED OPTIONS

	BASIC PRICE	VAT	MSRP
<b>Comfort Pack<sup>1)</sup>:</b> - 20" Silver alloy wheels - Driver door mirror memory with tilt-down function when in reverse - Driver Monitoring - Driver and front passenger electric slide, recline, height and lumbar adjustment - Front seat ventilation - Heated outer rear seats - Mazda Driver Personalisation System: (excludes steering wheel function & Ingress/Egress support)	£1,166.67	£233.33	£1,400
<b>Convenience &amp; Driver Assistance Pack<sup>2)</sup>:</b> - 360° Monitor with see through view - Qi Wireless Charging - 150W AC socket - Centre console storage illumination - Door pocket illumination with front & rear door courtesy lamps <sup>3)</sup> - Rear privacy glass - Cruising & Traffic Support - Intelligent Speed Assistance - Front Cross Traffic Alert - Smart Brake Support - Rear - Smart Brake Support - Rear Crossing - Mazda Radar Cruise Control (features Stop & Go function) - Adaptive LED Headlights	£1,583.33	£316.67	£1,900.00
<b>Panoramic sunroof<sup>4)</sup></b>	£833.33	£166.67	£1,000

<sup>1)</sup> Optional on Exclusive-Line models only.

<sup>2)</sup> Optional on Exclusive-Line, Homura & Takumi grades. Only available in conjunction with Comfort Pack on Exclusive-Line models. Standard on Homura Plus and Takumi Plus grades.

<sup>3)</sup> As part of the contents for Exclusive-Line grades. Item is as standard on all other grades.

<sup>4)</sup> Optional on Homura grades. Standard on Homura Plus and Takumi Plus grades.

## PAINT FINISH OPTIONS



ARCTIC WHITE | £0



PLATINUM QUARTZ | £650



SONIC SILVER | £650



ZIRCON SAND | £650



DEEP CRYSTAL BLUE | £650



JET BLACK | £650



MACHINE GREY | £750



RHODIUM WHITE | £750



SOUL RED CRYSTAL | £900

Use our car configurator to find the perfect Mazda CX-60 for you.



[BUILD YOUR MAZDA CX-60](#)

## MAZDA CX-60 INTERIOR TRIMS AND COLOURATION



Black leather seat trim<sup>^</sup>  
(EXCLUSIVE-LINE)



Black Nappa leather seat trim<sup>^</sup>  
(HOMURA & HOMURA PLUS)



White Nappa Leather seat trim<sup>^</sup>  
(TAKUMI & TAKUMI PLUS)



## MAZDA CX-60 ALLOY WHEELS



18" Grey alloy wheels  
(EXCLUSIVE-LINE)



20" Silver alloy wheels  
(OPTIONAL ON EXCLUSIVE-LINE  
AS PART OF THE COMFORT PACK)



20" Black alloy wheels  
(HOMURA & HOMURA PLUS)



20" Black Diamond Cut alloy wheels  
(TAKUMI & TAKUMI PLUS)

## OPTIONS & ACCESSORIES



ALLOY PEDAL SET  
£193.91



ILLUMINATED SCUFF PLATES  
£420.68



KEY COVER (VARIOUS COLOURS & STYLES)  
From £67.91



LUXURY FLOOR MATS  
£107.00



REAR BUMPER STEP PLATE  
£139.48



BOOT LINER  
£120.00

Options & Accessories: A small selection of our range of accessories are shown within this Price and Specification guide. For more information on the entire range of accessories we retail, please visit [www.mazda.co.uk/configurator](http://www.mazda.co.uk/configurator), select your vehicle and visit the 'Options & Accessories' section. The price shown is a non-binding recommendation of Mazda Motors UK, is subject to change and may not include extras such as painting. Alloy wheel prices do not include tyres. Accessory fitment costs may differ between Mazda dealers. For further information about Mazda Genuine Accessories and latest pricing including any fitment cost differences please contact your local Mazda dealer.

## OPTIONS & ACCESSORIES



ROOF RACK PACK  
£331.87



THULE ROOF BOX  
From £499.99



THULE BICYCLE CARRIER (EXCLUDING TOW BAR)  
£617.51



RETRACTABLE TOW BAR - SEMI-ELECTRIC  
PHEV - £1,278.50  
DIESEL - £1,237.87



MODE 3, 3-PHASE 7.5M CHARGING CABLE  
£307.12



MODE 2, TYPE 2, 8M CHARGING CABLE  
£313.99

Options & Accessories: A small selection of our range of accessories are shown within this Price and Specification guide. For more information on the entire range of accessories we retail, please visit [www.mazda.co.uk/configurator](http://www.mazda.co.uk/configurator), select your vehicle and visit the 'Options & Accessories' section. The price shown is a non-binding recommendation of Mazda Motors UK, is subject to change and may not include extras such as painting. Alloy wheel prices do not include tyres. Accessory fitment costs may differ between Mazda dealers. For further information about Mazda Genuine Accessories and latest pricing including any fitment cost differences please contact your local Mazda dealer.

# EQUIPMENT

		EXCLUSIVE-LINE	HOMURA	HOMURA PLUS	TAKUMI	TAKUMI PLUS
<b>EXTERIOR</b>						
B-Pillar and C-Pillar garnish:	Gloss Black	●	●	●	●	●
Door mirrors:	Body coloured	●	-	-	●	●
	Gloss Black	-	●	●	-	-
	Electrically adjustable	●	●	●	●	●
	Heated	●	●	●	●	●
	Auto power-folding	●	●	●	●	●
	Selectable tilt-down function when in reverse	○	●	●	●	●
	Auto-dimming (driver door)	●	●	●	●	●
	Memory	○	●	●	●	●
Front grille:	Gloss Black bar type	●	-	-	●	●
	Gloss Black Honeycomb	-	●	●	-	-
Front Signature Wing:	Bright	●	-	-	●	●
	Dark	-	●	●	-	-
Front wing - side garnish:	Bright	●	-	-	●	●
	Dark	-	●	●	-	-
Headlights:	Adaptive LED Headlights (ALH): Features 4 modes: - Glare-free High Beam - Highway mode - Marking light - Wide-range Low Beam	○	○	●	○	●
	Coming home / leaving home lights	●	●	●	●	●
	Dusk-sensing	●	●	●	●	●
	Washers	●	●	●	●	●
	High Beam Control (HBC): detects oncoming and preceding vehicles and automatically switches between high and low beams during night driving, making it easier for the driver to recognise hazards	●	●	-	●	-
	LED with auto headlight levelling	●	●	●	●	●
	Signature LED Daytime Running Lights	●	●	●	●	●
	Kodo turn signal - Distinctive light signature that starts at full power and then fades in sequential pulses	●	●	●	●	●
Parking aid:	Front and rear parking sensors	●	●	●	●	●
	Reversing camera (with static guidelines)	●	●	-	●	-
	360° View Monitor (front, rear and side cameras) with see through view and dynamic guide lines	○	○	●	○	●
Power liftgate:	With hands free function: Operational by button located on dashboard, key fob or button located on tailgate, or by passing your foot underneath the rear bumper with the key in your pocket or bag.	●	●	●	●	●
Privacy glass:	Rear side and rear windows	○	○	●	○	●
Rear lights:	Signature LED rear combination lights	●	●	●	●	●
Sunroof:	Electric Panoramic	-	○	●	-	●
Lower bumper, wheel arch and side mouldings:	Satin black	●	-	-	-	-
	Body coloured	-	●	●	●	●
Wheels & tyres:	18" Grey alloy wheels with 235/60 R18 tyres	●	-	-	-	-
	20" Silver alloy wheels with 235/50 R20 tyres	○	-	-	-	-
	20" Black alloy wheels with 235/50 R20 tyres	-	●	●	-	-
	20" Black Diamond Cut alloy wheels with 235/50 R20 tyres	-	-	-	●	●
Wipers:	Front, rain-sensing with adjustable sensitivity and speed	●	●	●	●	●
	Front wiper de-icer - Hot wires located along the drivers side A-pillar and the wiper finishing positions	●	●	●	●	●
	Low washer fluid warning lamp	●	●	●	●	●

● = Standard equipment, - = Not available, ○ = Optional as part of a pack. Please visit [mazda.co.uk](http://mazda.co.uk) for more information.

# EQUIPMENT

		EXCLUSIVE-LINE	HOMURA	HOMURA PLUS	TAKUMI	TAKUMI PLUS
<b>INTERIOR</b>						
Bright interior trim styling accents:	Steering wheel centre bezel, surround of start / stop button and glove box handle	●	●	●	●	●
Centre console panel:	Mesh Metal film detailing	●	-	-	-	-
	Matt Black Hairline film detailing	-	●	●	-	-
	White Maple wood	-	-	-	●	●
Door panel trim:	Black vinyl leather with Mesh Metal film inlay	●	-	-	-	-
	Black vinyl leather with Matt Black Hairline film inlay	-	●	●	-	-
	Woven fabric with White Maple wood inlay	-	-	-	●	●
Dashboard panel:	Black vinyl leather	●	-	-	-	-
	Black Cordovan-like vinyl leather	-	●	●	-	-
	Woven fabric with Kakenui inspired stitching	-	-	-	●	●
Parking Brake:	Electronic with auto-hold and auto-disengage function	●	●	●	●	●
Electrical power outlets:	12v (x1 front, x1 luggage compartment)	●	●	●	●	●
	150W AC socket	○	○	●	○	●
	1500W AC socket (PHEV models only)	○	○	●	○	●
Gear shift:	Leather-wrapped	●	●	●	●	●
Grab handles:	Driver, front passenger and two rear, with coat hooks	●	●	●	●	●
Instrument panel:	Trip computer	●	●	●	●	●
	12.3" TFT Colour driver display (provides speed, traffic signs and cruise control information)	●	●	●	●	●
Interior mirror:	Frameless, auto-dimming rear-view mirror	●	●	●	●	●
Interior trim:	Black leather seat trim^	●	-	-	-	-
	Black Nappa leather seat trim^	-	●	●	-	-
	White Nappa leather seat trim^	-	-	-	●	●
Roof Lining (ceiling and pillars):	Grey	●	-	-	●	●
	Black	-	●	●	-	-
Seats (Front):	Driver's seat manual tilt, slide, recline and height adjustment	●	-	-	-	-
	Driver's seat power tilt, slide, recline, height and lumbar adjustment	○	●	●	●	●
	Mazda Driver Personalisation System: (excludes steering wheel function)	○	-	-	-	-
	Mazda Driver Personalisation System: (seat / head up display / wing mirrors / steering wheel)	-	●	●	●	●
	Driver's seat ingress/ egress support & automatic driver position guide	-	●	●	●	●
	Passenger's seat manual slide, recline and height adjustment	●	-	-	-	-
	Passenger's seat power slide, recline, height and lumbar adjustment	○	●	●	●	●
	Heated with 3-stage setting	●	●	●	●	●
Ventilated with 3-stage setting	○	●	●	●	●	
Seats (Rear):	40:20:40 split fold down rear seat with remote fold down levers	●	●	●	●	●
	Heated outer rear seats with 3-stage setting	○	●	●	●	●
	Folding centre armrest equipped with two cup holders	●	●	●	●	●
	Manual recline adjustment	●	●	●	●	●
	Three height-adjustable head restraints	●	●	●	●	●
Steering wheel:	Heated, leather-wrapped with dark stitching and paddleshift for automatic transmission	●	●	●	-	-
	Heated, leather-wrapped with dual-tone white stitching and paddleshift for automatic transmission	-	-	-	●	●
	Manual telescopic and tilt adjustment	●	-	-	-	-
	Electric telescopic and tilt adjustment	-	●	●	●	●
Storage:	Cargo partition net	●	●	●	●	●
	Door storage (driver, front passenger and two rear)	●	●	●	●	●
	Centre storage with two cupholders	●	●	●	●	●
	Glovebox with interior illumination	●	●	●	●	●
	Roof mounted sunglasses holder	●	●	●	●	●
	Seatback pocket (located on rear of front driver and passenger seat)	●	●	●	●	●

● = Standard equipment, - = Not available, ○ = Optional as part of a pack. Please visit [mazda.co.uk](http://mazda.co.uk) for more information. ^Leather refers to centre seat facing and side supports.

# EQUIPMENT

		EXCLUSIVE-LINE	HOMURA	HOMURA PLUS	TAKUMI	TAKUMI PLUS
<b>INFOTAINMENT</b>						
Integrated Bluetooth®:	Allows audio transfer from Bluetooth® devices, hands-free calling and easy access to phone contacts via steering wheel controls or Multimedia Commander	●	●	●	●	●
Mazda Connect (Multimedia System):	AM / FM / DAB radio with 8 speakers	●	-	-	-	-
	AM / FM / DAB radio featuring 12-Speaker Bose surround sound system, with Bose CenterPoint, Bassmatch and AudioPilot technology.	-	●	●	●	●
	12.3" Colour centre display with touch-screen functionality for Apple CarPlay® and Android Auto™	●	●	●	●	●
	Steering wheel-mounted audio and Bluetooth® controls	●	●	●	●	●
	USB Type-C inputs (x2 front, x2 rear)	●	●	●	●	●
Mazda Connected Services <sup>1)</sup> :	Accessed via the MyMazda App which provides you with information about your vehicle, you can also access many other features like remote controls, vehicle finder and send a destination to your cars navigation system	●	●	●	●	●
Mazda Hybrid Navigation System:	European mapping with alternative route calculations, traffic updates, optimised point of interest search and 7-years free map updates	●	●	●	●	●
Multimedia Commander:	Located between the driver and front passenger, the Multimedia Commander allows easy control of the advanced connectivity and infotainment system, with information displayed on the 12.3" colour touch-screen, includes a separate volume control dial	●	●	●	●	●
Qi Wireless Charging	The Qi wireless charging tray is located on the central console allowing for wireless charging of your smartphone (where available)^	○	○	●	○	●
Wireless Apple CarPlay® & Android Auto™	In-car assistant systems that let you access certain features of your phone through Mazda Connect.	●	●	●	●	●

● = Standard equipment, - = Not available, ○ = Optional as part of a pack. Please visit [mazda.co.uk](http://mazda.co.uk) for more information.

<sup>1)</sup> Connected Services is a subscription service and requires a compatible mobile device to download and sign-up to the MyMazda App. A 7-year complimentary period is included and commences from the date of first registration of the vehicle. Please contact your dealer or visit [www.mazda.co.uk/my-mazda](http://www.mazda.co.uk/my-mazda) for further information.

		EXCLUSIVE-LINE	HOMURA	HOMURA PLUS	TAKUMI	TAKUMI PLUS
<b>COMFORT AND CONVENIENCE</b>						
Air-conditioning:	Dual-zone climate control air-conditioning with rear air-vents	●	●	●	●	●
Cruise Control:	With manual speed adjustment and adjustable speed limiter	●	●	-	●	-
	Mazda Radar Cruise Control (MRCC) (features Stop & Go function)	○	○	●	○	●
Cruising & Traffic Support (CTS):	Where conditions allow, assists driver with accelerator, brake and steering functions when following a vehicle ahead in heavy traffic, helping to reduce driver fatigue.	○	○	●	○	●
Electric windows:	Front and rear with one-touch function	●	●	●	●	●
Kinematic Posture Control (KPC):	Applies a very small amount of brake force to the inner wheel during cornering, the resulting brake force pulls the body down, suppressing body roll to improve cornering	●	●	●	●	●
Head-Up Display:	Windscreen Projected Colour Active Driving Display (Head-Up Display): Projects full-colour information directly onto the windscreen within the driver's line of sight, including navigation, speed and vehicle status.	●	●	●	●	●
Intelligent Speed Assistance (ISA):	A driver operated speed-limiting system that works in conjunction with Traffic Sign Recognition (TSR) to help keep drivers from exceeding the speed limit unintentionally. Ahere to the shown speed limit shown within the instrument panel by pressing the 'RES' button on the steering wheel.	○	○	●	○	●
Interior lighting:	Front & rear with LED illumination	●	●	●	●	●
	Top-down centre console illumination with front & rear footwell lighting	●	●	●	●	●
	Centre console storage illumination	○	○	●	○	●
	Door pocket illumination with front & rear door courtesy lamps	○	●	●	●	●
Interior ambient lighting:	Provides illumination to the door panel trim	-	●	●	●	●
Luggage compartment:	LED illumination	●	●	●	●	●
	Retractable tonneau cover	●	●	●	●	●
Mi-DRIVE:	Normal mode	●	●	●	●	●
	Sport mode	●	●	●	●	●
	Off-road mode (AWD models only)	●	●	●	●	●
	Towing mode (AWD models only)	●	●	●	●	●
	EV Mode (PHEV models only)	●	●	●	●	●
Ignition Start / Stop button		●	●	●	●	●
Sun Visors:	Driver's and front passenger's with covered vanity mirror and driver's ticket holder	●	●	●	●	●

● = Standard equipment, - = Not available, ○ = Optional as part of a pack.

# EQUIPMENT

		EXCLUSIVE-LINE	HOMURA	HOMURA PLUS	TAKUMI	TAKUMI PLUS
<b>SAFETY AND SECURITY</b>						
Airbag:	Front dual stage driver and single stage front passenger	●	●	●	●	●
	Front and rear side airbags	●	●	●	●	●
	Front central airbag	●	●	●	●	●
	Front and rear curtain airbags	●	●	●	●	●
	Front driver knee airbag	●	●	●	●	●
	Front passenger airbag deactivation system (auto switch)	●	●	●	●	●
Alarm & Immobiliser	Thatcham approved immobiliser and an alarm meeting ECE requirements	●	●	●	●	●
Anti-lock Braking System (ABS):	Prevents the wheels from locking, caused by braking on slippery roads, and maintains driving directional stability and ensures steerability	●	●	●	●	●
Blind Spot Monitoring (BSM):	Using radars mounted in the rear bumper to detect vehicles approaching from behind and in the adjacent lane. It alerts the driver with audible and visual warnings to the presence of vehicles in their blind spot on either side of the vehicle.	●	●	●	●	●
Driver Attention Alert (DAA):	Designed to reduce accidents caused by inattentiveness due to driver fatigue. The system watches inputs and the vehicle's movements in the early stages before fatigue is a factor.	●	●	●	●	●
Driver Monitoring (DM):	Uses the Driver Monitoring Camera to alert the driver if drowsy or inattentive driving is detected	○	●	●	●	●
Dynamic Stability Control (DSC):	Automatically controls braking and engine power output in conjunction with systems such as the ABS and TCS to help control side slip when driving on slippery surfaces, or during sudden or evasive steering, which enhances vehicle stability.	●	●	●	●	●
e-Call with GPS:	In the case of an accident, either provides a manual or automated message to the emergency services, which includes the vehicle's location. (European locations only).	●	●	●	●	●
Emergency Stop Signalling system (ESS)	If sudden braking is applied, the ESS rapidly flashes all the direction indicator lights to caution drivers behind your vehicle of the sudden braking situation. The ESS operates when sudden braking is applied while the vehicle speed is approximately 34 mph or faster.	●	●	●	●	●
Emergency tyre repair kit:	Included with your Mazda is for a temporary repair of a slightly damaged flat tyre resulting from running over nails or similar sharp objects on the road surface. Perform the emergency flat tyre repair without removing the nail or similar sharp object which punctured the tyre	●	●	●	●	●
Emergency Lane-Keeping:	Blind Spot Assist - Assists steering operation when changing lanes despite the risk of a potential collision. It detects vehicles approaching from the rear or side of the vehicle when the vehicle is travelling at approximately 37mph or above.	●	●	●	●	●
	Road Keep Assist - Enhanced camera function to enable the detection of grass and curbs along the roadside to help prevent departure from the road even on roads without lanes. Activates when the vehicle is traveling at approximately 37mph or above, assisting steering operation when there is a risk that the vehicle may depart from the road.	●	●	●	●	●
Front Cross Traffic Alert (FCTA):	When pulling out of junctions, the system checks for approaching vehicles in your blind spots either side or the front of your vehicle. When an oncoming vehicle is detected, it sounds a warning	○	○	●	○	●
Hill Descent Control (AWD models only):	Supports safe downhill driving on steep slopes with slippery, rough road surfaces such as offroad terrain or snow-covered hills. It does this by automatically keeping the car at a constant speed without the driver needing to operate the brakes.	●	●	●	●	●
Hill Launch Assist (HLA):	When starting off from an incline, HLA helps prevent the car from rolling backwards when the driver moves their foot from the brake to the accelerator pedal by maintaining an automatic brake.	●	●	●	●	●
ISOFIX child seat anchorage:	Attached to outer rear seats	●	●	●	●	●
Lane Departure Warning System (LDWS):	Notifies the driver that the vehicle might be deviating from its lane. If there is a possibility of your vehicle deviating from the vehicle lane, a screen display and a warning sound notify the driver of the danger.	●	●	●	●	●
Lane-keep Assist System (LAS):	Working in harmony with the Lane Departure Warning System, LAS helps the driver stay within the vehicle lane if the vehicle might be deviating. If your vehicle may be deviating from the vehicle lane, the LAS provides steering assistance to avoid departure from the lane.	●	●	●	●	●

● = Standard equipment, - = Not available, ○ = Optional as part of a pack.

continued >

# EQUIPMENT

SAFETY AND SECURITY continued		EXCLUSIVE-LINE	HOMURA	HOMURA PLUS	TAKUMI	TAKUMI PLUS
Pre-crash safety:	Smart Brake Support Front (SBS) - SBS is a system designed to avoid or reduce damage in the event of a collision by controlling the brakes. Sensors and camera equipped on the vehicle detects objects, and operate brake control if there is a possibility of your vehicle colliding with the object. The system also features:- - Turn-Across Traffic - Designed to assist the driver in avoiding a collision with a vehicle approaching in the opposite direction when making a right turn at an intersection and to reduce damage in the event of a collision.	●	●	●	●	●
	Smart Brake Support Rear (SBS-R) - designed to reduce the risk of accidents by helping the driver avoid rear-end collisions by applying automatic braking.	○	○	●	○	●
	Smart Brake Support Rear Crossing (SBS-RC) - detects vehicles approaching from the rear left and right sides of the vehicle, and the rear of the vehicle while the vehicle is being reversed out of a parking space, and applies the brakes	○	○	●	○	●
Rear Cross Traffic Alert (RCTA):	Designed to help you make sure it's safe to start backing up. The system uses the same radars and indicators as BSM to watch for vehicles coming from both sides, and alerts the driver when they come near.	●	●	●	●	●
Remote central locking with deadlocking and automatic door lock when driving		●	●	●	●	●
Smart keyless entry:	Allows opening and locking of the vehicle without removing the key from your pocket or bag	●	●	●	●	●
Seatbelt reminder audible warning:	Driver, passenger and rear seats	●	●	●	●	●
Traffic Sign Recognition (TSR) with intelligent speed assist:	Utilising the front sensing camera and Navigation data, this system is designed to notify the driver of traffic signs by displaying them on the instrument panel and the head-up display. If the vehicle exceeds the recognised speed limit, an audible tone will be activated.	●	●	●	●	●
Tyre Pressure Monitoring System (TPMS):	Monitors the air pressure of each tyre and informs the driver of a decrease in pressure when it becomes lower than the specified air pressure.	●	●	●	●	●
Trailer Stability Control (TSC):	TSC is a system that increases the stability of the vehicle during towing. When vehicle sway occurs during towing, the TSC controls the output of the brakes and the engine to suppress swaying.	●	●	●	●	●
Vehicle exit warning:	Assists the driver in checking the rear of the vehicle when exiting the vehicle. When a vehicle or bicycle approaching from the rear is detected, various screen displays and warning sounds notify the driver of the danger	●	●	●	●	●

ELECTRIFICATION (PHEV ONLY)		EXCLUSIVE-LINE	HOMURA	HOMURA PLUS	TAKUMI	TAKUMI PLUS
Vehicle Charging:	Type 2 Mode 2 cable for AC charging via UK 3-pin plug	●	●	●	●	●
	Type 2 Mode 3 cable for AC charging via home or public charge points	●	●	●	●	●

●= Standard equipment, - = Not available, ○ = Optional as part of a pack

# TECHNICAL INFORMATION

Model Availability	2.5 e-SKYACTIV PHEV AWD 327ps Automatic	3.3 e-SKYACTIV D MHEV RWD 200ps Automatic	3.3 e-SKYACTIV D MHEV AWD 254ps Automatic
Exclusive-Line	●	●	●
Homura	●	-	●
Homura Plus	●	-	●
Takumi	●	-	●
Takumi Plus	●	-	●

Dimensions	2.5 e-SKYACTIV PHEV AWD 327ps Automatic	3.3 e-SKYACTIV D MHEV AWD 200ps Automatic	3.3 e-SKYACTIV D MHEV AWD 254ps Automatic
Overall length / width <sup>1)</sup> / height (mm) <sup>2)</sup>	4,745 / 1,890 (2,134) / 1,675 (1,680)		
Wheelbase (mm)	2,870		
Ground clearance between the axles (mm) - unladen 18" / 20" alloys	176 / 182	174 / 179	173 / 179
Front track / Rear track (mm)	1,640 / 1,645		
Front headroom <sup>3)</sup> / leg room / shoulder room (mm)	1,004 (991) / 1,058 / 1,504		
Rear headroom <sup>3)</sup> / leg room / shoulder room (mm)	984 (960) / 990 / 1,441		
Cargo volume, acc. to VDA (l):	570		
	5-seat mode to belt line including underfloor storage		
	1,726		
Brake Type - Front & Rear	Ventilated Discs		
Brake Dimensions - Front / Rear (mm)	347 / 328	328 / 328	328 / 328

Steering	2.5 e-SKYACTIV PHEV AWD 327ps Automatic	3.3 e-SKYACTIV D MHEV AWD 200ps Automatic	3.3 e-SKYACTIV D MHEV AWD 254ps Automatic
Steering gear	Electronic Power Assist System (EPAS) rack-and-pinion		
Wall to Wall turning circle (M)	11.7		

<sup>1)</sup> Vehicle width excludes mirrors. Figures in brackets includes mirrors opened.

<sup>2)</sup> Figures in brackets are for vehicles fitted with 20" alloy wheels.

<sup>3)</sup> Figures in brackets are for vehicles fitted with panoramic sunroof.

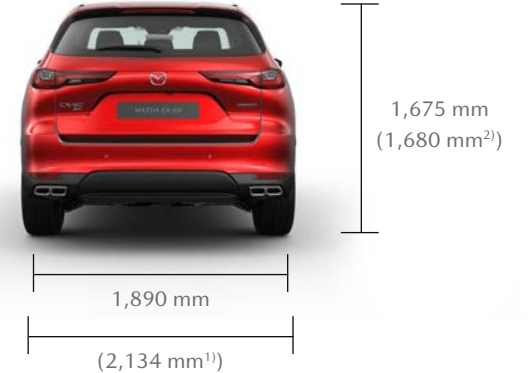
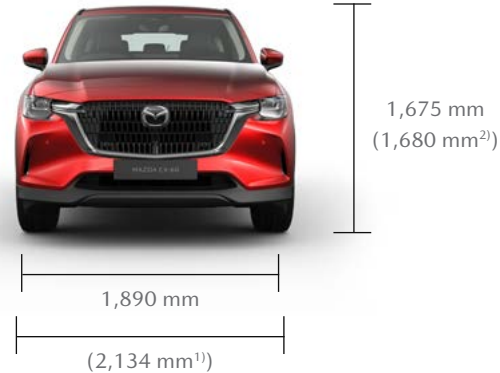
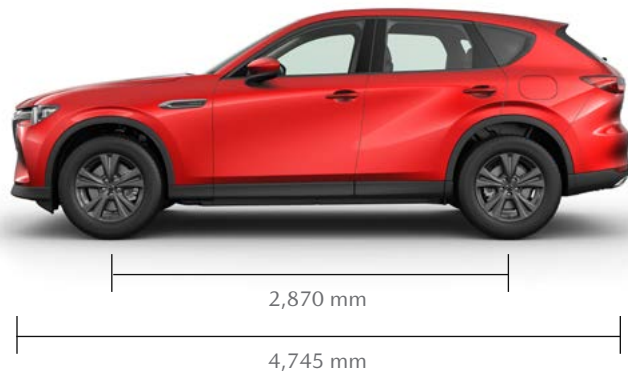

# TECHNICAL INFORMATION

		2.5 e-SKYACTIV PHEV AWD 327ps Automatic	3.3 e-SKYACTIV D MHEV AWD 200ps Automatic	3.3 e-SKYACTIV D MHEV AWD 254ps Automatic
Displacement (cc)		2488	3283	3283
Bore x Stroke (mm)		89.0 x 100.0	86.0 x 94.2	86.0 x 94.2
Number of cylinders		4	6	6
Compression ratio		13:1	15.2:1	15.2:1
Transmission		8-Speed Automatic	8-Speed Automatic	8-Speed Automatic
<b>Fuel Saving Technology</b>				
i-stop system		●	●	●
Mazda M Hybrid Boost 48-volt battery		-	●	●
Plug-in Hybrid System (PHEV)		●	-	-
<b>Electrification</b>				
Battery Size		17.8kWh	0.3kWh	0.3kWh
Battery Type		Lithium-ion	Lithium-ion	Lithium-ion
Battery Weight (kg)		176	-	-
Battery Voltage (V)		355	44.4	44.4
On-board charger		7.2kW	-	-
<b>Performance</b>				
Maximum power output	Total ps (KW) / rpm	327 (241) / 6,000	200 (147) / 3,600-4,200	254 (187) / 3,750
	Electric Motor	129kW	12.4kW	12.4kW
Max. torque (Nm / rpm)		500 / 4,000	450 / 1,400-3,000	550 / 1,500-2,400
Acceleration (0-62 mph in seconds)		5.8	8.4	7.4
Top Speed (mph)		124	132	136
<b>Fuel Economy and CO<sub>2</sub> Emissions</b>				
WLTP fuel consumption mpg (l/100km) <sup>1)</sup>	Low	29.4 (9.6)	48.7 (5.8) - 49.6 (5.7)	44.1 (6.4) - 45.6 (6.2)
	Medium	38.2 (7.4) - 38.7 (7.3)	60.1 (4.7) - 61.4 (4.6)	54.3 (5.2) - 56.5 (5.0)
	High	41.5 (6.8)	64.2 (4.4) - 65.7 (4.3)	60.1 (4.7) - 62.8 (4.5)
	Extra High	34.4 (8.2)	50.4 (5.6) - 51.4 (5.5)	47.9 (5.9) - 48.7 (5.8)
	Combined	36.2 (7.8)	55.4 (5.1) - 56.5 (5.0)	51.4 (5.5) - 53.3 (5.3)
	weighted combined*	201.8 (1.4)	-	-
Equivalent all-electric range <sup>1)</sup>		39.15 - 39.77 miles	-	-
WLTP electric energy consumption (miles/kWh) (weighted combined) <sup>1)</sup>		2.7	-	-
WLTP CO <sub>2</sub> emissions (g/km) <sup>1)</sup>	weighted combined*	33 - 32	-	-
	combined	-	131 - 130	142 - 138
EC emission level <sup>1)</sup>		Euro Stage 6	Euro Stage 6	Euro Stage 6
Recommended fuel		Unleaded 95 RON	Diesel	Diesel
Fuel tank capacity (litres)		50	58	58
AdBlue® - Selective Catalytic Reduction (SCR system) is designed to purify and reduce nitrogen oxide (NOx) in the exhaust gas, by injecting it with AdBlue®		-	●	●
AdBlue® tank capacity (litres)		-	13.3	13.3
<b>Charging</b>				
Mode 3 AC via home or public charger 7.2kW (20-80%)		1 hour, 30 minutes	-	-
Mode 2 AC via UK 3-pin plug socket 2.4kW (20-80%)		4 hours, 50 minutes	-	-
<b>Weights</b>				
Minimum Kerb weight (kg) excl. driver (18"/20" alloy wheels)		1,995 / 2,057	1,832 / 1,853	1,870 / 1,944
Maximum Kerb weight (kg) incl. driver (18"/20" alloy wheels)		2,128 / 2,147	1,920 / 1,942	1,961 / 2,025
Permitted gross vehicle weight (kg)	Total	2,667	2,500	2,516
Towing limit <sup>2)</sup> (kg):		2,500	2,500	2,500
Maximum roof load (kg)		100	100	100

\* These figures were obtained using a combination of battery power and fuel. The Mazda CX-60 is a plug-in hybrid vehicle requiring mains electricity for charging.

<sup>1)</sup> Figures shown are for comparability purposes and may reflect Euro 6d or Euro 6e testing procedures. Please speak to your Mazda dealer for confirmation; only compare fuel consumption and CO<sub>2</sub> figures with other cars tested to the same technical procedures. These figures may not reflect real life driving results, which will depend upon a number of factors including the accessories fitted (post-registration), variations in weather, driving styles and vehicle load. All figures quoted are derived from the latest WLTP test cycle.

<sup>2)</sup> Towing capacity is based on a 12% gradient and tested in accordance with 92/21/EEC as amended by 95/48/EC

## THE LATEST IN TECHNOLOGY & CONVENIENCE

### e-SKYACTIV PHEV – PLUG-IN HYBRID ELECTRIC VEHICLE

In order to achieve better environmental performance without compromising on the intuitive driving you come to expect from a Mazda, we developed our first Plug-in Hybrid vehicle, the Mazda CX-60. Ideal for those drivers who want to transition into the EV lifestyle.

This e-Skyactiv Plug-in Hybrid SUV is the most powerful car Mazda has produced. It is equipped with a naturally-aspirated four-cylinder 2.5-litre engine, coupled with a 129KW electric motor and a 355V, 17.8kWh high-capacity lithium-ion battery. This combination of engine and motor delivers a total system output of 327ps and 500Nm of torque.

Mazda's first PHEV also displays outstanding environmental credentials with the ability to drive up to 39.15 - 39.77 miles of electric motor-powered driving, meaning that the vehicle will use no petrol and produce 0g/km of CO<sub>2</sub>. Using a combination of both petrol and electric driving, the Mazda CX-60 provides WLTP weighted combined fuel consumption of 201.8mpg, and WLTP weighted combined CO<sub>2</sub> emissions from only 32g/km.

#### CHARGING OVERVIEW

##### What you need to know...

- The Mazda CX-60 is compatible with the most common charging connectors (Type2) for both at home and out-of-home charging, via AC.
- Charging cables and power sockets are completely waterproof so can be used at any time to charge your Mazda CX-60.
- The sockets lock into the car, meaning it is secure and safe to leave unattended.
- A Type 2 Mode 2 cable for AC charging via a UK 3-pin plug and a Type 2 Mode 3 cable for AC charging via home or public charge points are both included with the car.
- Maximum charge of 7.2kW taking approximately 2 hours 20 minutes to charge from 0-100%.<sup>^</sup>



<sup>\*</sup>Figures shown are for comparability purposes; only compare fuel/energy consumption and CO<sub>2</sub> figures with other cars tested to the same technical procedures. These figures may not reflect real life driving results, which will depend upon a number of factors including the starting charge of the battery, accessories fitted (post-registration), variations in weather, driving styles and vehicle load, and use of features such as air conditioning or heated seats. All figures quoted are derived from the latest WLTP test cycle. For BiK purposes, 39.15 - 39.77 miles is rounded up to 40 miles as per HMRC legislation and therefore qualifies for 9% BiK 2025/26.

<sup>^</sup>Charging times are based on an ambient temperature of 20°C and will vary depending on a variety of factors including the output of the charger being used, ambient temperature and battery state.

## e-SKYACTIV D MHEV – MILD HYBRID ELECTRIC VEHICLE

For those who frequently drive long distances or need to regularly tow heavy loads, we have developed the latest in Diesel engine technology.

Our 3.3-litre in-line six-cylinder e-Skyactiv D diesel engine features Distribution-Controlled Partially Premixed Compression Ignition (DCPCI) Technology. This highly innovative advanced combustion technology makes the new e-Skyactiv D one of the cleanest diesel engines in the world.



Developed using our 'right sizing' concept which optimises displacement to improve both fuel and power efficiency, the all-new direct injection inline-six cylinder e-Skyactiv D is available with a choice of two power outputs: 200ps with rear-wheel drive which provides 450Nm of torque, and 254ps with Mazda i-Activ AWD (all-wheel drive) which provides 550Nm of torque.

Both Diesel powertrains feature a new 48v Mazda M Hybrid Boost system. Our innovative evolution of mild hybrid vehicle technology uses three main components to capture energy that is normally wasted during braking. It stores that energy within the 48v Lithium-ion Battery and uses it to assist the engine and power the car's electrical systems, meaning you can drive further on a tank of fuel whilst also contributing to lower CO<sub>2</sub> emissions and other particulates.

## SKYACTIV-VEHICLE DYNAMICS: TRANSMISSIONS, CHASSIS AND DYNAMICS



### TRANSMISSIONS

Mazda's eight-speed automatic transmission is designed to offer drivers a smooth and responsive gear shift with slick steps between ratios, achieving the right balance between driver engagement, comfort, dynamic performance and environmental efficiency.

This transmission replaces the torque converter with a clutch, so that the torque of the engine and the electric motor is transmitted directly, with a similar fast shifting feel akin to a manual transmission.



### SKYACTIV-CHASSIS

Providing a lightweight chassis that delivers driving pleasure and comfort, leading to that pure 'Jinba-ittai' oneness between car and driver.

The perfectly fine tuned chassis provides our famed driving experience of agility at low and medium speeds, and stability at motorway speeds for both driving pleasure and comfort.



### DYNAMICS

In order to offer a driving experience that makes it possible for drivers to control a more powerful car and enjoy an exciting driving feel, the Mazda CX-60 uses Skyactiv Multi-Solution Scalable Architecture, our new vehicle architecture technology that's compatible with a longitudinal engine and rear-wheel-drive layout.

Skyactiv Multi-Solution Scalable Architecture features numerous enhancements that improve that Jinba-Ittai driving feeling, such as rigidity that ensures drivers can feel vehicle response without lag, seats that make it even easier for everyone in the car to maintain balance while the car is moving, and suspension that stabilises vehicle posture while driving. As a result, the Mazda CX-60 makes it possible for drivers to enjoy a truly great drive.

# ADVANCED SAFETY TECHNOLOGY



## DRIVER MONITORING

Detects sleepiness or inattention by monitoring changes in expression or movement of the driver's line of sight. A camera and infrared LED monitor the driver's condition both day and night. If the system determines that the driver has fallen asleep or is inattentive, it sounds an alert to make the driver aware while also setting up for automatic braking to help prepare for a potential incident.

(Optional as part of Comfort Pack on Exclusive-Line, standard on Homura, Homura Plus, Takumi & Takumi Plus)



## COLOUR ACTIVE DRIVING DISPLAY (HEAD-UP DISPLAY)

The system projects full-colour information directly onto the windscreen within the driver's line of sight. The displayed information includes Traffic Sign Recognition, Mazda navigation turn-by-turn directions, as well as vehicle status including current speed and advanced safety equipment status.

(Standard across the range)



## MAZDA DRIVER PERSONALISATION SYSTEM

The Mazda Driver Personalisation System recognises the driver using the camera inside the vehicle, and automatically restores various driver settings that have been stored. This includes a function that automatically adjusts the driver's seat, Active Driving Display, outer mirror angle and steering wheel position based on the driver's physique. The system will also move the seat and the steering wheel so that the driver can easily enter and exit the vehicle.

(Optional as part of Comfort Pack on Exclusive-Line (excludes steering wheel function & Ingress/Egress support), standard on Homura, Homura Plus, Takumi & Takumi Plus)

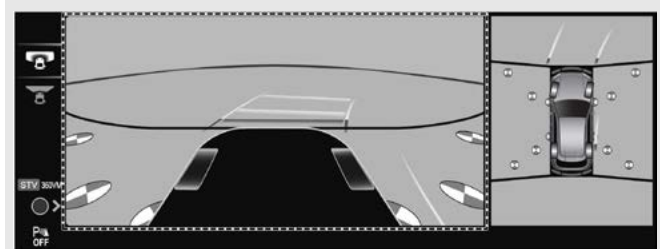

## 360° VIEW MONITOR WITH SEE-THROUGH VIEW

Displays a 360° image using front, side and rear cameras with guide lines to assist in checking the area at the front, rear and sides of the vehicle when driving forward, parking or stopping. See-Through View provides a display of the front or rear of the vehicle as though it was transparent.

(Optional as part of Convenience & Driver Assistance Pack on Exclusive-Line, Homura & Takumi. Standard on Homura Plus and Takumi Plus)

# ADVANCED SAFETY TECHNOLOGY

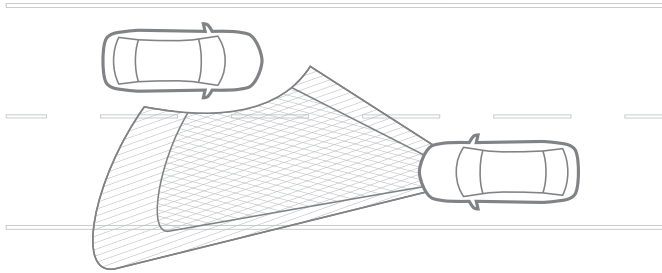

## ADAPTIVE LED HEADLIGHTS

Mazda's Adaptive LED Headlights provide the ultimate in headlight technology, lighting up the road ahead as if it were daytime and allowing anybody to enjoy safe and stress-free driving at any time. The system increases visibility at night to help drivers stay vigilant by combining four technologies: Wide-range Low Beams which light up a wider area at low speeds, Marking light which brightly illuminates pedestrians that may collide with the vehicle, Highway mode which helps you see further when travelling at speed, and Glare-free High Beams which automatically dim part of the illuminated area to avoid dazzling other drivers.

(Optional as part of Convenience & Driver Assistance Pack on Exclusive-Line, Homura & Takumi. Standard on Homura Plus and Takumi Plus)

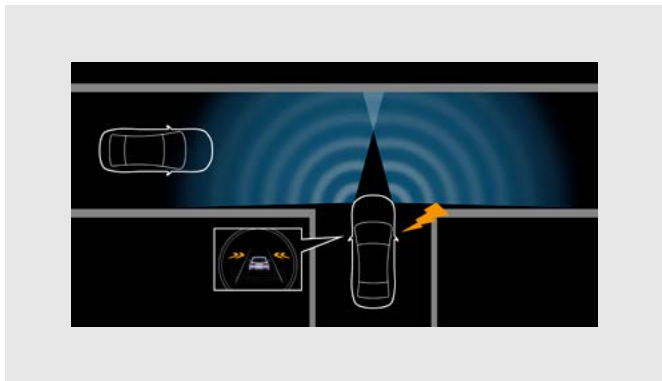

## FRONT CROSS TRAFFIC ALERT

Mazda's newly developed system detects other vehicles approaching from blind spots at the front right or left of the vehicle, and alerts the driver of their presence. If the driver depresses the accelerator and the system detects an oncoming vehicle, it will operate the brakes to stop or reduce the chance of a collision. This helps prevent a common cause of accidents when cars enter a T-junction with a partially obscured view.

(Optional as part of Convenience & Driver Assistance Pack on Exclusive-Line, Homura & Takumi. Standard on Homura Plus and Takumi Plus)

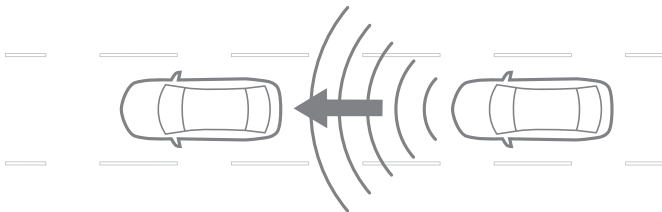

## MAZDA RADAR CRUISE CONTROL

To activate, the driver sets a maximum speed (just as with cruise control) and size of the gap to maintain. The radar watches for traffic ahead and once the system senses a vehicle in front, the car will slow down and speed up automatically maintaining the drivers pre-set distance. The system also features 'Stop & Go' function, meaning the vehicle will automatically accelerate and brake in start/stop traffic with minimal input from the driver.

(Optional as part of Convenience & Driver Assistance Pack on Exclusive-Line, Homura & Takumi. Standard on Homura Plus and Takumi Plus)

# ADVANCED SAFETY TECHNOLOGY

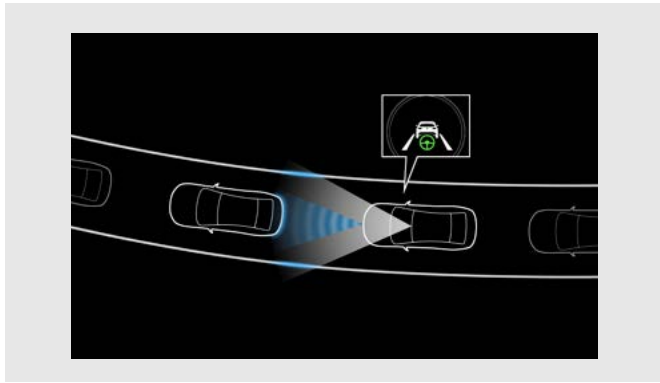

## CRUISING & TRAFFIC SUPPORT (CTS)

Automatically operates acceleration and braking to maintain a proper trailing distance between your Mazda and the vehicle ahead. In addition, it assists with steering operations to keep the car within its lane. CTS contributes to reducing driver fatigue, as well as supporting a safer, more reassuring and more comfortable driving experience.

(Optional as part of Convenience & Driver Assistance Pack on Exclusive-Line, Homura & Takumi. Standard on Homura Plus and Takumi Plus)

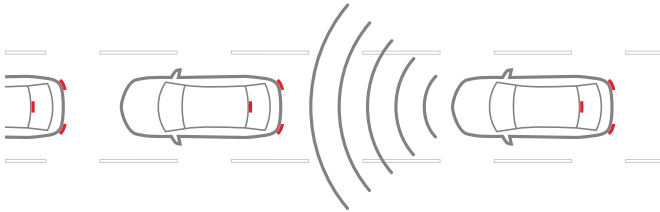

## SMART BRAKE SUPPORT – FRONT WITH TURN-ACROSS TRAFFIC

SBS alerts the driver of a possible collision using the warning indications in the display, and a warning sound if the front radar sensor and Forward Sensing Camera determine that there is the possibility of a collision with a vehicle, pedestrian, or a bicycle ahead. Furthermore, if a collision is unavoidable, the automatic brake control is performed to reduce damage in the event of a collision. In addition, when the driver depresses the brake pedal, the brakes are applied firmly and quickly to assist.

The Turn-Across Traffic function is designed to assist the driver in avoiding a collision (or reducing the impact) with a vehicle approaching in the opposite direction when making a turn at a junction.

(Standard across the range)

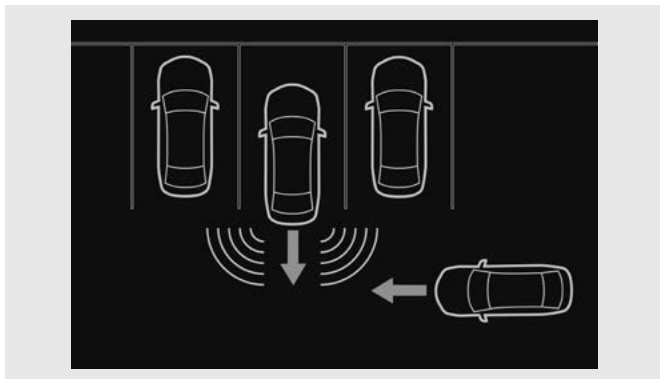

## SMART BRAKE SUPPORT – REAR

Reduces damage in the event of a collision by operating the brake control when the system's sensors detect an obstruction at the rear.

## SMART BRAKE SUPPORT – REAR CROSSING

Assists in avoiding collisions and reducing damage whilst the vehicle is in reverse. If there is the possibility of an impact with a vehicle approaching from the rear, the system will apply the brakes.

(Optional as part of Convenience & Driver Assistance Pack on Exclusive-Line, Homura & Takumi. Standard on Homura Plus and Takumi Plus)

# ADVANCED SAFETY TECHNOLOGY

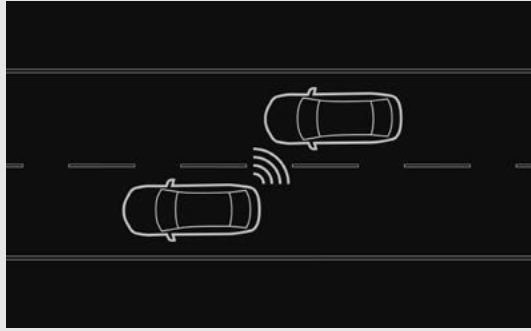

## BLIND SPOT MONITORING (BSM) WITH REAR CROSS TRAFFIC ALERT (RCTA)

BSM uses radars mounted in the rear bumper to detect vehicles approaching from behind and in the adjacent lane. It alerts the driver to the presence of vehicles in the blind spot on either side by displaying an icon in the appropriate door mirror. If the driver indicates to change lanes with a vehicle in the blind spot, the icon flashes and a warning beep is sounded.

RCTA is designed to help you make sure it's safe to start backing up. The system uses the same radars and indicators as BSM to watch for vehicles coming from both sides, and alerts the driver when they come near.

(Standard across the range)

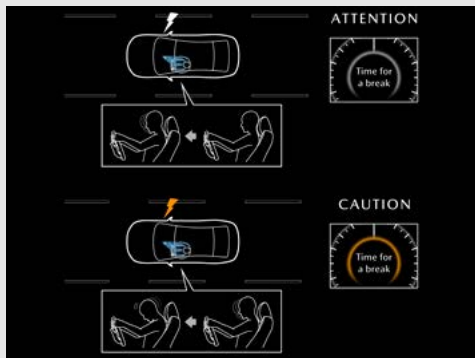

## DRIVER ATTENTION ALERT

Designed to reduce accidents caused by inattentiveness due to driver fatigue. The system comes into play at speeds above 41mph and begins to "learn" the driver's habits, watching inputs and the vehicle's movements in the early stages before fatigue is a factor. Later, if the system detects changes in vehicle behaviour that suggest the driver may be losing concentration, it will suggest a rest stop by sounding a chime and displaying a warning in the Multi-Information Display.

(Standard across the range)

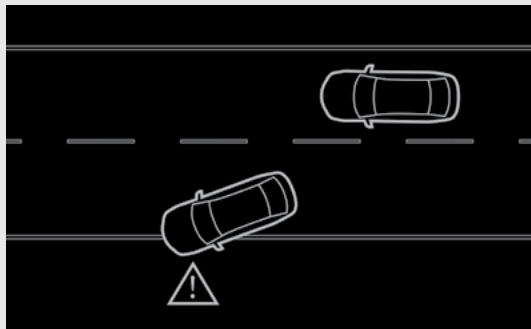

## LANE-KEEP ASSIST SYSTEM WITH LANE DEPARTURE WARNING SYSTEM

Designed to prevent your vehicle from inadvertently straying from its lane. A front view camera monitors the road ahead and calculates the car's position relative to the lane markings. If the system detects the vehicle is moving out of its lane unintentionally, the steering wheel will vibrate and an audible alert will sound. The system will also take corrective action to help you stay within the lanes through assisted steering.

(Standard across the range)

# VEHICLE TAX RATES

## VEHICLE TAX RATES TAX YEAR 2025-26

CO <sub>2</sub> EMISSIONS FIGURE (G/KM)	ALL CARS FIRST YEAR RATE	ALL CARS STANDARD RATE (12 months)
0	£10	£195
1-50	£110	£195
51-75	£130	£195
76-90	£270	£195
91-100	£350	£195
101-110	£390	£195
111-130	£440	£195
131-150	£540	£195
151-170	£1,360	£195
171-190	£2,190	£195
191-225	£3,300	£195
226-255	£4,680	£195
Over 255	£5,490	£195

First-year rate is paid when first registering a vehicle and is for the first 12 months Vehicle Excise Duty. After the first 12 months, the standard rate applicable at that time is payable. Vehicles with a list price >£40k will be subject to a premium of £425 over the Standard Rate for 5 years from the start of the second licence.

## WARRANTY

All Mazda cars registered from 1st September 2025 will benefit from a six-year manufacturer's warranty, or 100,000 miles, whichever comes first.



## e-SKYACTIV PHEV BATTERY WARRANTY

MODEL	WARRANTY PERIOD
e-SKYACTIV PHEV	8-year / 100,000 mile warranty

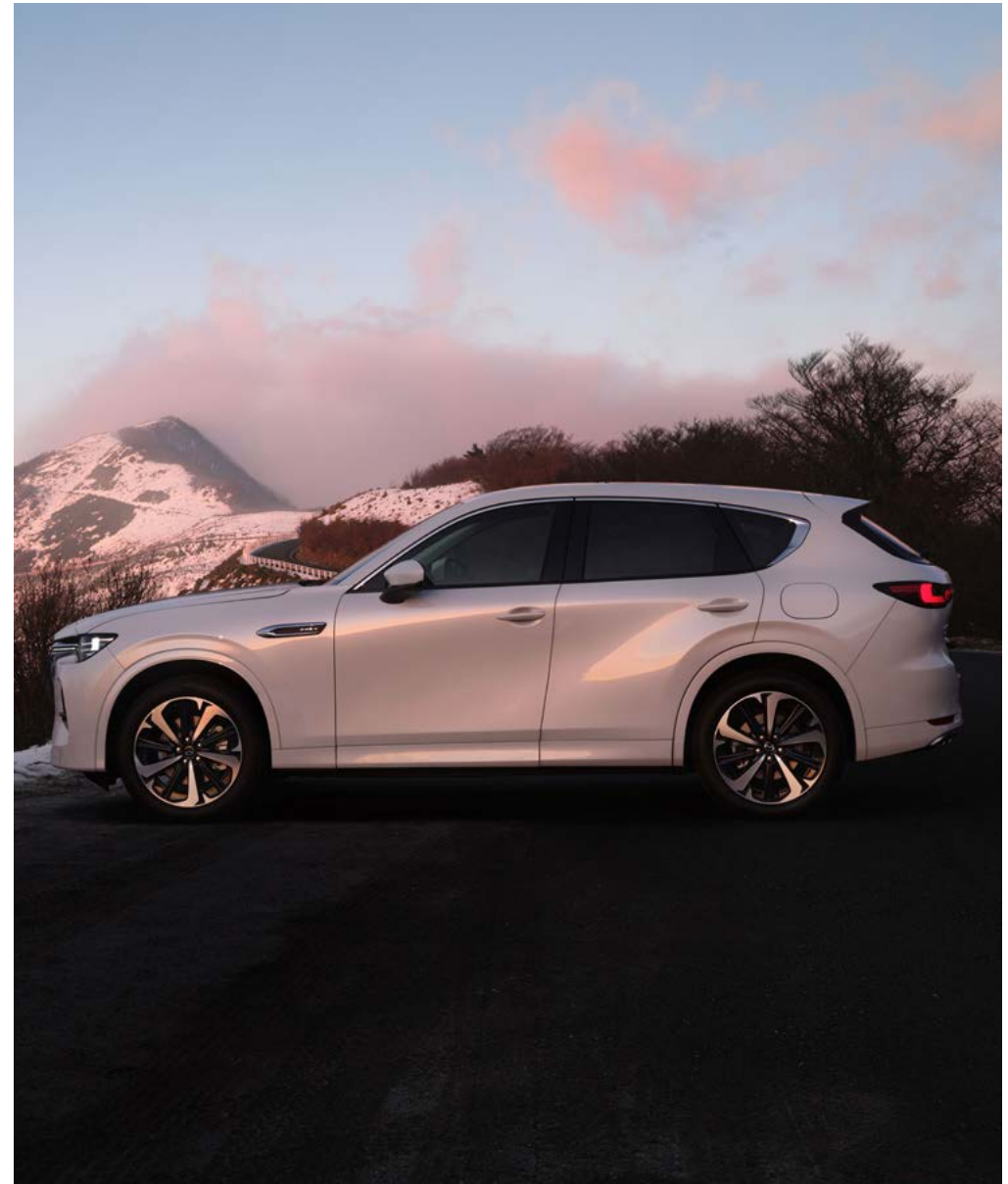

# MAZDA SERVICES

The maximum service interval for your Mazda is 12,500 miles or 12 months whichever occurs first, however, the servicing intervals may reduce based on the style of driving and the conditions under which your vehicle is operated.



## MAZDA FINANCIAL SERVICES

Mazda Financial Services offers a variety of finance and insurance products to suit the needs of both private and business customers. With our wide range of plans and services, no-one is more committed to delivering complete motoring confidence and total peace of mind than Mazda and Mazda Financial Services.†



## MAZDA EXCESS RETURN VOUCHER

When you apply for Free Driveaway Insurance for your new Mazda, you'll also receive a free 1-year Excess Return voucher which pays back up to £250 of your insurance excess cost, regardless of who you're insured with, if you use our Call Mazda First service. If you have a Mazda Excess Return voucher and need to make an insurance claim, simply Call Mazda First before your insurer on 0800 015 0367.



## MAZDA INSURANCE

When you buy your new Mazda from a Mazda franchised dealer, we'll give you free comprehensive Driveaway Insurance so you can get on the road there and then. Upgrade to our annual cover and benefit from our Mazda Accident Repair Promise all year round. In the event of an accident, unlike most other insurers, we guarantee to repair your Mazda at a Mazda Approved Bodyshop using only Mazda Genuine Parts. This helps to protect your Mazda's safety rating, resale value and manufacturer warranty. Plus, you'll also get windscreen damage cover, EU cover and a complimentary courtesy car. We'll even pay your cancellation fee if you're insured elsewhere\*. Eligibility criteria, terms and conditions apply.

Ask your dealer or call Mazda Insurance on 0330 102 7995.

Get a quote online at [www.mazdacarinsurance.co.uk](http://www.mazdacarinsurance.co.uk)

Mazda Insurance is arranged and administered by Verex Insurance Services Ltd which arranges policies from a panel of insurers.

\*Offer not available online. Offer conditions apply.



## FREE MAZDA ACCIDENT AFTERCARE

In the event of an accident, Call Mazda First 0800 015 0367 before your insurer for free 24-hour Accident AfterCare and to redeem your £250 Excess Return voucher. Our dedicated case handlers will liaise with your insurer and arrange Mazda Genuine Parts and repairs at a Mazda Approved Bodyshop, keeping your Mazda 100% Mazda and maintaining your Mazda warranties. We'll also provide accident recovery if your Mazda isn't driveable and a free courtesy car during the repair. Terms and conditions apply.

Save 0800 015 0367 to your mobile phone.

### TAX FREE – DIPLOMATIC AND MILITARY SALES

For further information contact your Mazda dealer or contact Mazda on 03457 48 48 48.

### MOTABILITY

For all Motability enquiries please contact your Mazda dealer or contact Mazda on 03457 48 48 48.

# STAY IN TOUCH WITH MAZDA CX-60

Visit our website and use the Configurator to create your perfect version of the Mazda CX-60.



**BUILD YOUR MAZDA CX-60**



Or get answers to all your questions by requesting more information here.



FIND A DEALER



REQUEST A TEST DRIVE



REQUEST A QUOTE



FOLLOW US ON



# CRAFTED IN JAPAN

## SEPTEMBER 2025

Mazda Motors UK reserves the right to introduce changes in specification and equipment due to its ongoing product development. Prices are subject to change without prior notice. Colour and trim samples shown in this digital brochure may vary from the actual colours because of the variations of resolutions and colours found in various screen displays, and if printed, limitations within the printing process. Models shown may not be to UK specification. It is recommended that you consult your Mazda dealer when referring to these. Apple CarPlay®, Android Auto™ and Bose are registered trademarks in the U.S. and other countries. Used with permission. Amazon, Alexa, and other related marks are trademarks of Amazon.com, Inc. or its affiliates. The Bluetooth® word mark and logos are owned by the Bluetooth SIG, Inc. and any use of such marks by Mazda Motor Company is under licence. Other trademarks and trade names are those of their respective owners.

Amazon Alexa is a cloud-based voice service provided by Amazon, which is provided under Amazon's own responsibility. To use Alexa, you need an Amazon account. Mazda only enables the use of Amazon Alexa in selected Mazda models and is not responsible for providing the Alexa services. Amazon's terms of use and privacy policy apply.

To use the Alexa functions in your Mazda vehicle, you must also register with Mazda Connected Services via the MyMazda app. For more information about Mazda Connected Services and the processing of data in this context, please refer to [www.mazda.eu/en/mazda-in-europe](http://www.mazda.eu/en/mazda-in-europe). Alternatively, Alexa can be used by connecting the vehicle to a mobile WiFi hotspot. This may incur additional costs depending on your mobile phone tariff.

Amazon, Alexa, and other related marks are trademarks of Amazon.com, Inc. or its affiliates. Amazon Alexa is currently available in English, German, French, Italian, and Spanish. The Mazda Connect system language and home region setting must be set to a language and country supported by Amazon Alexa. In Europe these countries currently are the following: Germany, France, Ireland, Italy, Austria, Spain, United Kingdom.